

单元1 在家里

连一连。

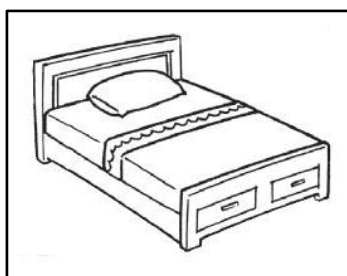
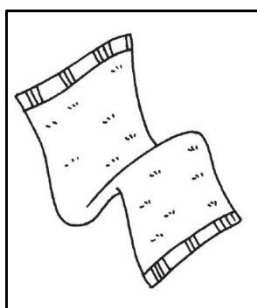
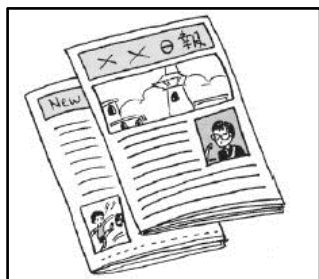
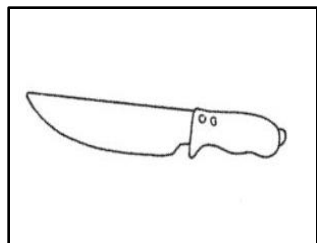

刀

床

灯

牙刷

报纸

肥皂

毛巾

沙发

镜子

锅

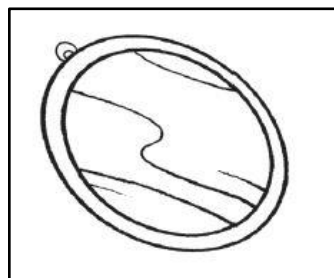
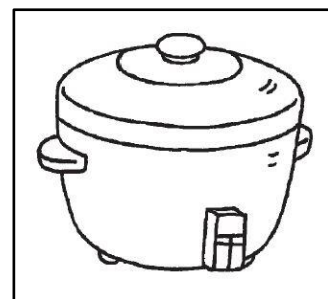
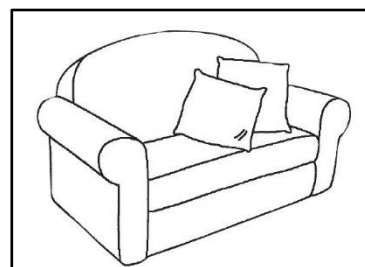
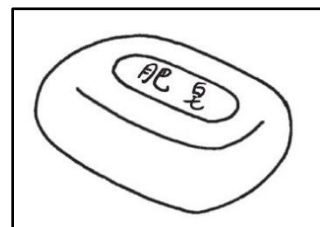
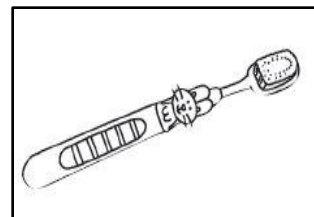

单元2 在家里

连一连。

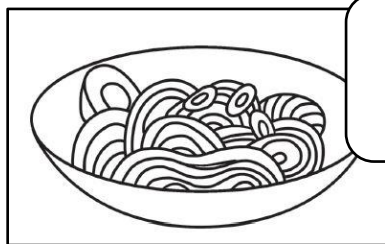

面



牛

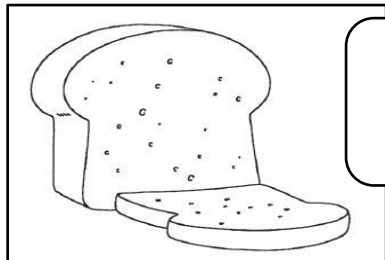

面

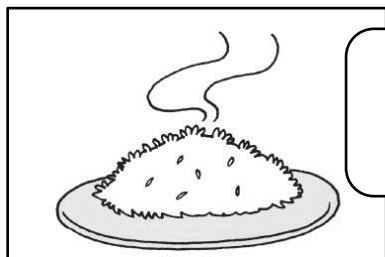

米



果

汁

条

奶

包

饭

单元3 在游乐场

看图，空格里应该填上什么字？写出正确的字母。

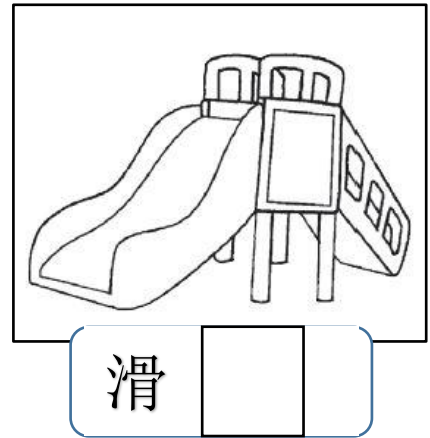
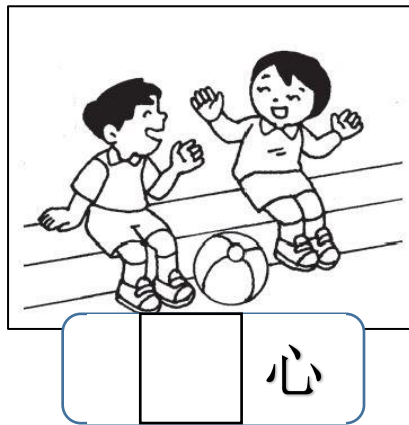
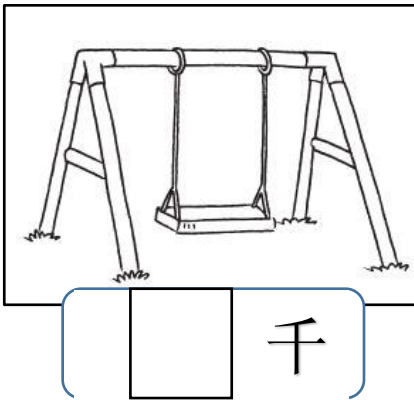
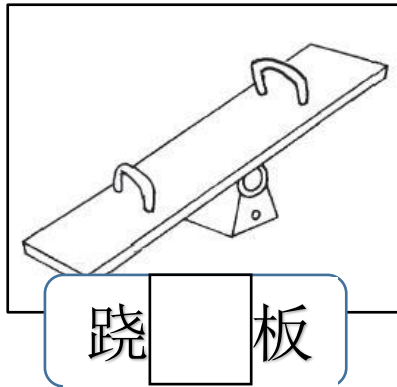

- A 跷 B 心 C 开 D 梯 E 秋 F 生